

Article number: 03551090

Description: Fluro hydraulic rod end FPR 90CE

Measures

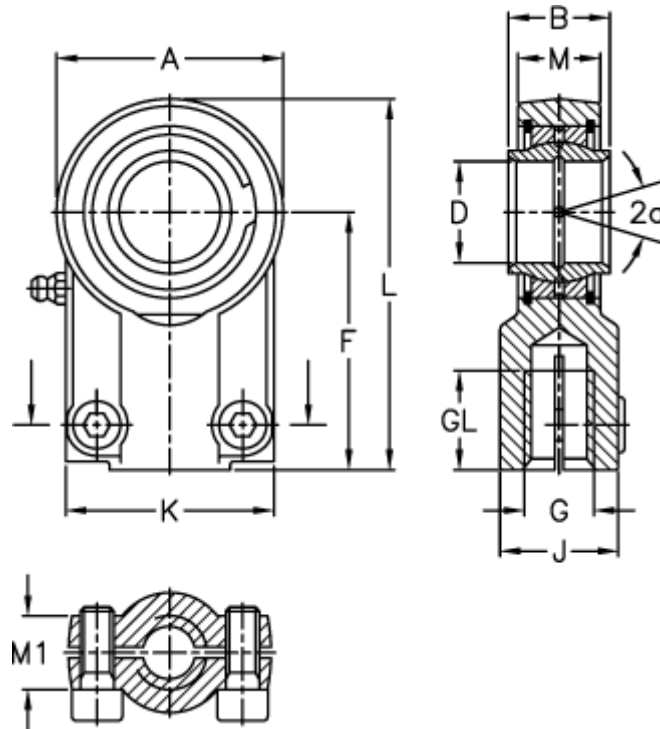

A	= 185	J	= 100
a (degrees)	= 4	K	= 160
B	= 90	L	= 296
D	= 90	M	= 72
Dynamic load C (kN)	= 490	M1	= 52
F	= 195	Static load C0 (kN)	= 750
g	= M72x3	Torque (N m)	= 410
GL	= 91	Weight	= 17500